

# Scrap wood Wren House

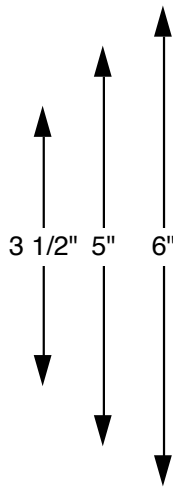
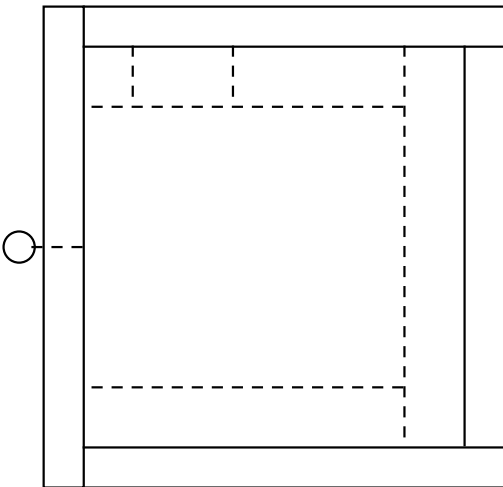
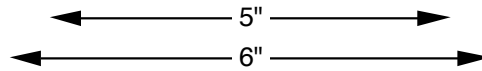
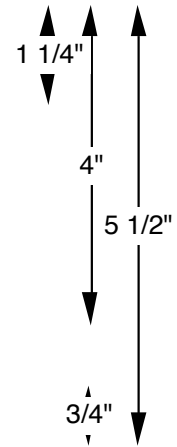
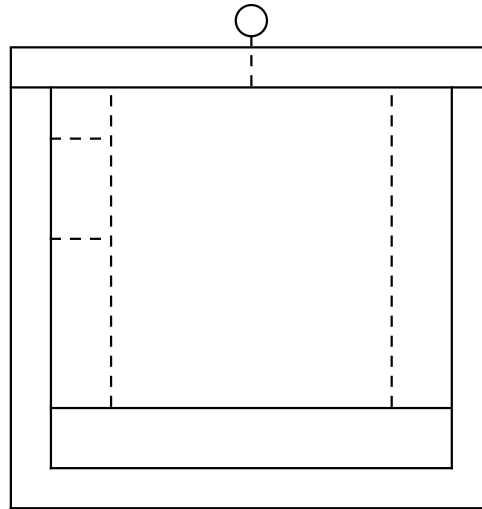
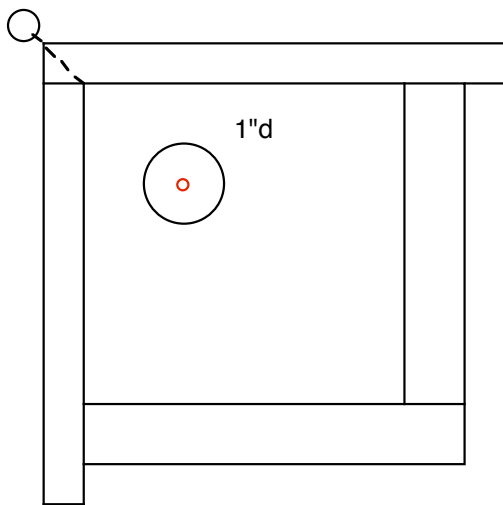

Drawing shows 1/2" top and 3/4" front, back and bottom.

Materials:

3/4" thick

2 - 4 x 4 front & back

1/4 to 1/2" thick

1 - 5 x 4 bottom

1 - 5 x 4 + \* bottom

1 - 6 x 5-1/4 top

1 - 6 x 5 + \*\* top\*

\* = thickness of bottom board

\*\* = thickness of top board

screw in eyelet

12" wire

- 1 1/4" -

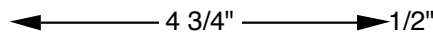
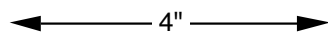

1/2"

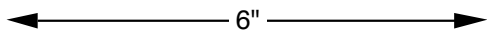

## Bird (Wren) House Information

Assemble the box as shown in the photo. Roman numerals are on the pieces to aid your assembly. Match the numerals on two pieces. Use exterior glue and nails or screws on all parts **EXCEPT** the back. The back should be screwed but not glued so it can be removed for cleaning. Put a screw part way in the center of the back as a handle to pull it out. Drill a hole through the peak at the center and add a wire for hanging. If the hole goes through to the inside, seal it to prevent water from leaking in. Alternately you can put in a screw eye to use for hanging. Paint the outside to make it last longer. You can paint it plain or decorative.



**Information from *Woodworking for Wildlife* by Carrol L. Henderson, MN DNR.**

### House Wren

The house wren is one of our most common and enjoyable backyard birds. Its beautiful bubbling calls are a joy to hear during the summer.

House wren nest boxes are likely to be used if they are 5-10 feet above the ground and located under the eave of a building or in a tree. This is the only kind of bird house which can be free-hanging. All other bird houses need to be firmly anchored. House wren holes are too small for house sparrows or European starlings to use. Don't put a perch on the nest box. Perches invite sparrows to try using the nest. If you have a perch on a wren house, take it off.

The entrance hole for a wren house should be 1-inch in diameter. If you increase the hole to 1-1/4-inches it allows it to be used by chickadees and nuthatches, but not house sparrows.

House wrens generally nest in wooded, shrubby habitats. Their nests are characterized by twigs and the 6-8 eggs are finely speckled with reddish spots. Sometimes wrens will take over the nest of a tree swallow or eastern bluebird after puncturing the eggs of the other birds with their bills.

As soon as one family of wrens leaves a house, clean it out so another brood of young ones can be raised.

**Cleaning** - To clean the square box remove screws to remove the back and the clean out the nest box

**Winter** – It is best to leave the nest box open by removing back or bring it inside during the winter to prevent mice from using it for a nest. They will prevent the birds from using it in the spring.

## **White breasted Nuthatch**

The white breasted nuthatch is well known at winter bird feeders as it hangs upside down to eat suet and probe for insect larvae under the bark of trees. It will also nest in mature hardwood forests in habitat similar to that used by chickadees.

Nuthatches need an entrance 1-1/4 inch diameter. House should be 12-20 feet off the ground. As soon as each brood of young leaves the nest box, clean it out (see above) so more birds can use it.

## **Black-capped Chickadee**

The black-capped chickadee was selected as Minnesota's favorite bird during an informal survey conducted by DNR. Many people enjoy these delightful birds at their feeders every winter but don't realize they will also nest in yards and wood-lots with mature hardwood trees.

The square house will be used by black-capped chickadees if placed in the proper habitat. Chickadees need an entrance 1-1/4 inch diameter. The house should be mounted 5-15 feet high with 40-60 percent sunlight. About an inch of sawdust should be placed at the bottom of the nest box.